

IXM INGUIDE

Quick Start Guide

MERGE 2

MERGE CR

Invidium Customer Portal

Stay up to date with:

Latest Updates

Best Practices

Datasheets

Installation Guides

Feature Description Documents

Videos

FAQs

Tutorials

And more...

Visit <https://www.invidium.com/support/>



In the Box



Getting Started

- 1 Remove the Mounting Plate, Wired Back Cover and Screws from the IXM INSTALL KIT.
 - 2 Install the Mounting Plate at the desired location (INVIXIUM recommends 120-130 cms from the floor to the bottom of the device).
 - 3 Make the necessary connections to the Wired Back Cover (refer to [Get Wired Pages](#)).
 - 4 Unscrew and remove the Temporary Back Cover from the IXM device and connect the Wired Back Cover using the same screws.
 - 5 Hang your IXM device on the Mounting Plate and secure it on the bottom with the screw provided.
- W6973 7m theclck



Get Wired Glossary

ACP	Access Control Panel	OTG	On-The-Go
COM	Common	RLY	Relay
DAC	Door Access Control	SGND	Signal Ground
DGND	Digital Ground	SPO	Specific Purpose Output
EGND	Earth Ground	TAMPER	Tamper
GND	Ground	VIN+	Power (12VDC)
NC	Normally Closed	VIN-	Power Ground
NO	Normally Open	WDATA	Wiegand Data

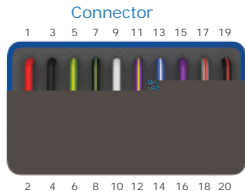

Get Wired Connector

Wire Color	Wire	Label	Pin(s)	Wire Color	Wire	Label	Pin(s)
Red		VIN+	1	Blue/Black		RS485- (A)	2
Black		VIN-	3	Blue		RS485+(B)	4
Green/Yellow		EGND	5	Orange		DAC_OUT	6
Black/Green		DGND	7	Orange/Yellow		SPO_1	8
White		WDATA_OUT1	9	Green		WDATA_OUT0	10
Purple/Yellow		DAC_IN2	11	White/Purple		DAC_IN1	12
Blue/White		DAC_IN3	13	Green/White		WDATA_IN0	14
Purple		TAMPER	15	White/Black		WDATA_IN1	16
Grey/Red		RLY_NO	17	Grey		RLY_COM	18
Black/Red		SGND	19	White/Red		RLY_NC	20

Earth Ground

For protection against Electrostatic Discharge, Invixium recommends the use of a ground connection between each IXM device to a high quality Earth Ground available at the install site.

Connect to Earth Ground in the following way:

- 1 Connect the green and yellow earthing wire from the wired back cover (PIN 5) to the building earthing.
- 2 Connect the open end of earth ground wire provided in the Install Kit Box to the building earthing as well.
- 3 Screw the lug end of the earth ground wire to the metal mounting plate.

Ensure all Earth Ground connections are made to each device prior to turning on the power.

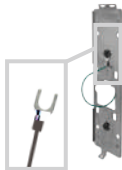

Earth Ground Connections

Power It Up

When using an external power supply, ensure that the regulated, filtered and dedicated power source (Safety tested, FCC/IC/CE certified) provides a minimum of 1A @ 12 VDC.

When using PoE, an IEEE 802.3af compliant Active Midspan Injector is required (sold separately). Refer to table for Invixium recommended PoE Injector specs. Full PoE deployments should include a centralized PoE PSE. Both IEEE 802.3af power transmission modes (A and B) are supported. Invixium recommends the use of battery back up or a UPS with built-in surge protection to provide supply to PSE unit & DC source.



INVIXIUM recommended PoE Injector Specs

Input Voltage	90-264 VAC, 60 Hz
Input Current	0.4 A @ 100 VAC
Output Voltage	48 VDC
Output Current	0.32 A
Power	15.36 Watt

WARNING: Product Warranty is void if improper power (under or over) is supplied to the device.

IXM WEB

Router connected
to LAN/WAN

USB Serial Communication

For Serial Communication, IXM devices are equipped with USB Aux port.

The USB port can be used to connect a Flash Drive via Micro USB OTG cable and perform functions like upgrading firmware, downloading transaction logs and configuration files.

The USB port can also be used to connect to a PC running IXM WEB via Micro USB cable.



Micro USB Cable
(Sold Separately)

Micro USB OTG Cable
(Sold Separately)

Bottom USB Port

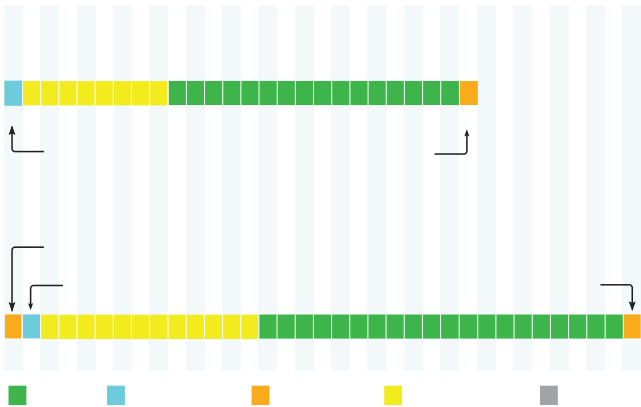

ACP Connections

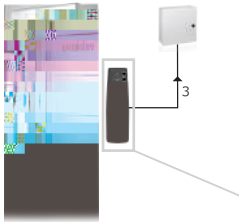

Wiegand Connections

- WDATA_OUT0 (10) 
- WDATA_OUT1 (9) 
- DGND (7) 

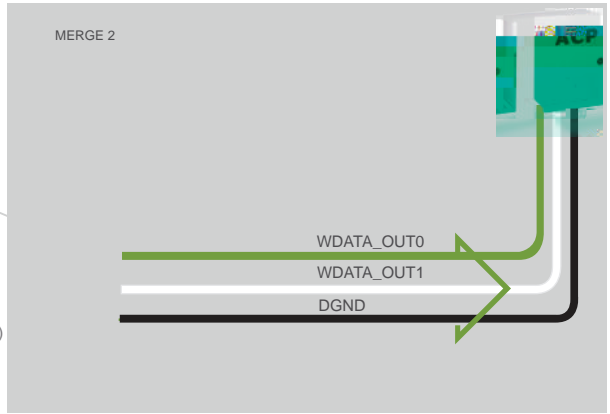

DAC Connections (Magnetic Lock)

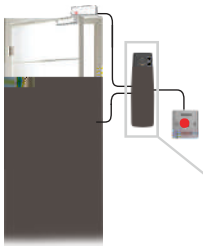

DAC Connections

DAC_OUT		(6)
DAC_IN2		(11)
DAC_IN1		(12)
RLY_COM		(18)
RLY_NC		(20)

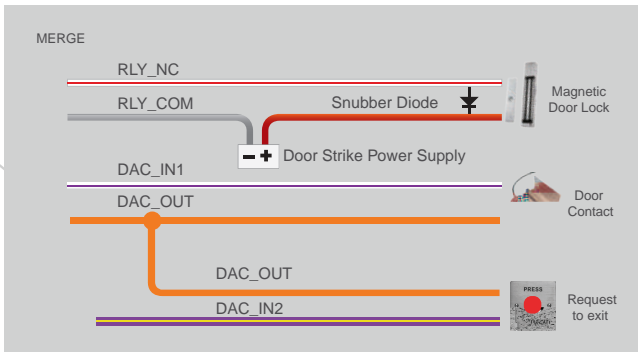

Max Relay Rating = 2A @ 24VDC

NOTE: A separate power supply is required for the door strike

Enrollment Best Practices

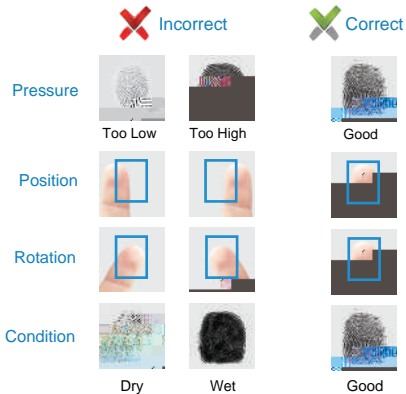

Finger Placement Best Practices

1. Proper finger placement is crucial for good enrollment score and faster authentication.
2. Place your finger straight on the sensor as shown below, while covering the sensor with the top third of your finger as shown on the previous page.



Incorrect



Correct



Card Placement

1. The location of the card reader on Invixium devices depends on the product model.
2. For MERGE 2, the card reader is located below the sensor, behind the emblem.
3. See the image on the right for the correct card placement while using MERGE 2.

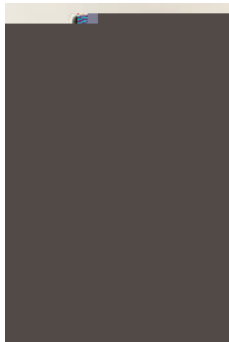

MERGE 2

Software Installation

- 1 Go to www.invixium.com >> IXM WEB >> Get IXM WEB.
- 2 You will be redirected to ixmweb.invixium.com. Click on the IXM WEB Tab. Provide the required details and Click "Submit". An email with the latest IXM WEB package will be sent to the email ID provided.
- 3 Extract the compressed file and run IXM WEB.exe.
- 4 INVIXIUM recommends to select **Install** option for rapid installation.
- 5 When installation is complete, click **Exit**. IXM WEB icon is now on the desktop.
- 6 Run IXM WEB to launch in default web browser.
- 7 Contact support@invixium.com in case of any issues.



INGUIDE

This is a Quick Start Guide. For a detailed guide please refer the Invixium Installation Guide.

For technical or customer support issues, please contact your Local Authorized Reseller first.

Visit the Customer Portal for more Invixium resources at www.invixium.com/support

Enjoy the Experience.

Some features may vary based on device models. Copyright © 2020, INVIXIUM. All rights reserved.

Contact Invixium Support at:

invixium.com

© 2020 Google Inc. All rights reserved. Chrome™ browser is a trademark of Google Inc.
Firefox logo® is a registered trademark of the Mozilla Foundation.
Windows®, Internet Explorer® and Edge® are trademarks of the Microsoft group of companies.
Safari® is a trademark of Apple Inc.

P/N XAD-00E-209-01G